

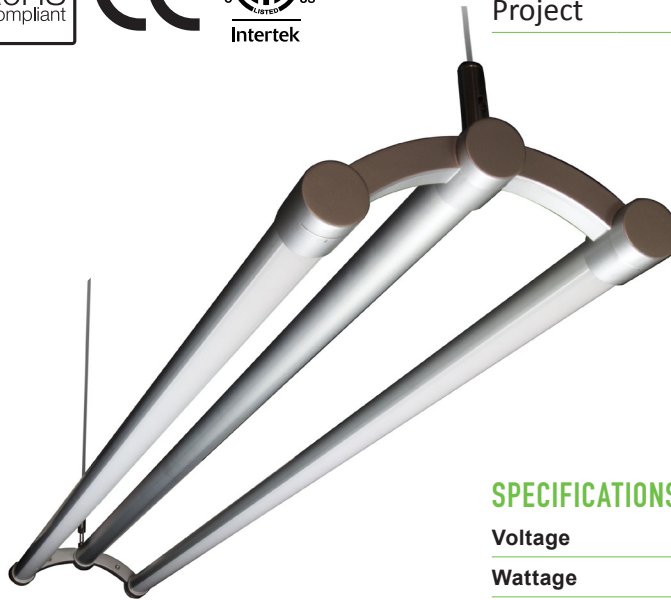

Item # \_\_\_\_\_

Project \_\_\_\_\_



ITEM #	CCT (KELVIN)	CRI	LUMENS <sup>1</sup>
DI-24V-ES30-**	3000K	90+	4560
DI-24V-ES40-**	4000K	90+	4560

\*\* Substitute with **SV** for silver, or **BL** for black.

## AVAILABLE IN:

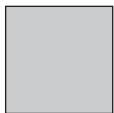

Silver



Black

## SPECIFICATIONS

<b>Voltage</b>	24VDC
<b>Wattage</b>	60W
<b>Fixture Dimensions</b>	49.8 x 8.6 x 2.8 in. (L x W x H)
<b>Power Cable Dimensions</b>	72" x .12" (L x Dia.)
<b>Suspension Cable Dimensions</b>	72" x .06" (L x Dia.)
<b>Dimmable</b>	Yes
<b>Rotation (Per Tube)</b>	355°
<b>Housing</b>	Aluminum
<b>Premium Diffused</b>	Yes
<b>Included Items</b>	(2) Suspension Cables, (2) Mounting Hardware, and (1) Canopy, (1) End-to-end Connector
<b>Warranty</b>	3-Year Warranty
<b>Luminous Efficacy<sup>2</sup></b>	79 (lm/w)
<b>Environment<sup>3</sup></b>	Damp / Indoor only
<b>Ambient Temp<sup>4</sup></b>	-4 ~ 122°F (120 ~ 50°C)
<b>Operating Temp<sup>5</sup></b>	-4 ~ 176°F (120 ~ 80°C)

**SKU Builder**

DI

--

Model & Color Temp                      Color

ES30

SV

ES40

BL

Example: **DI-ES30-BL** = Diode, EMERY™ ENSEMBLE, 3,000° CCT, 4560 Lumens, Black.

# EMERY™ Ensemble Suspended Linear LED Fixture

SPECIFICATION SHEET

## MECHANICAL DIAGRAM

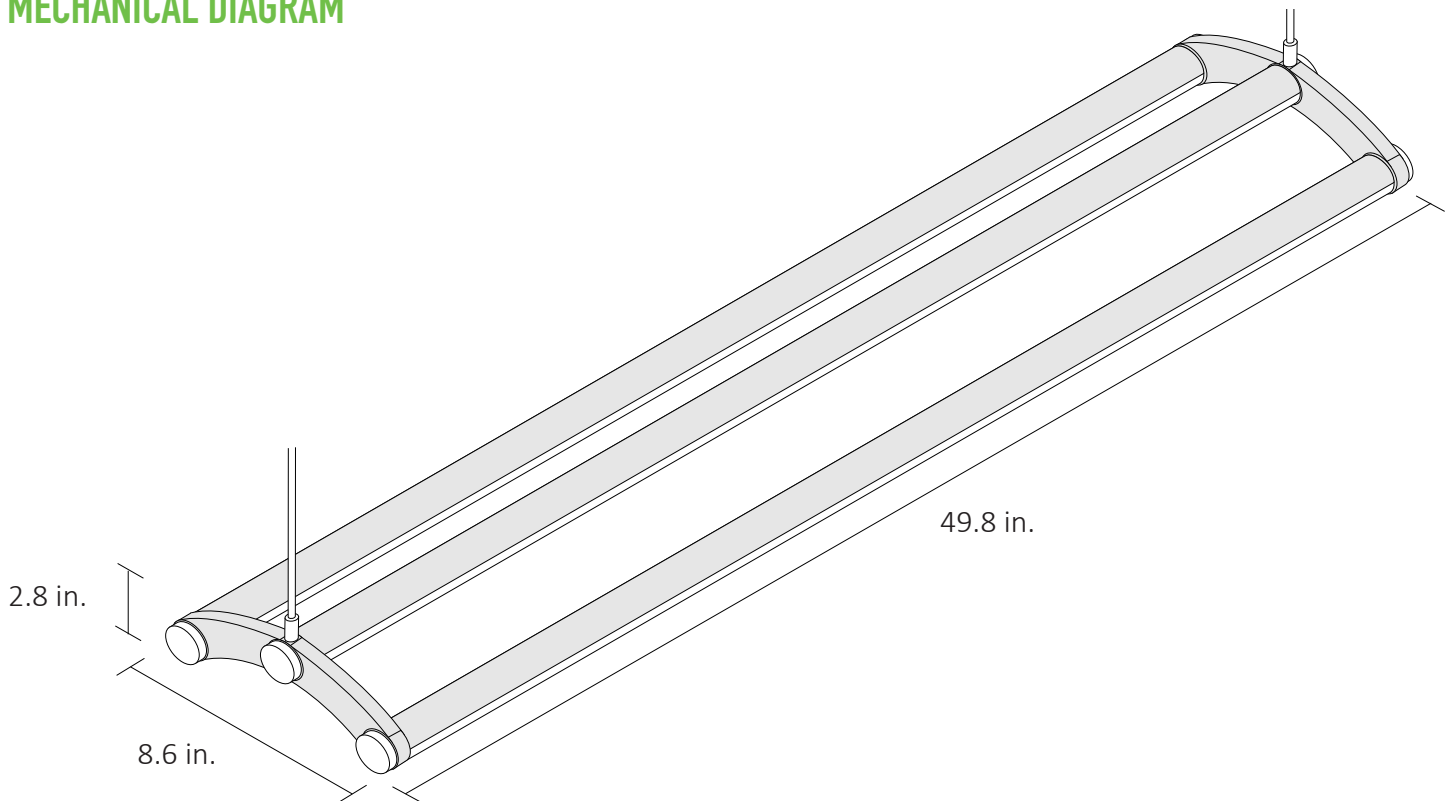

## COMPLIANCE & REGULATORY APPROVALS

### Safety

- ETL Listed
- CE & EMC Compliant: Verification No. GZEM141200683705V

### Environmental

- RoHS Compliant: Verification No. CANEC1610091501

1. LED chips have a luminous flux range with a tolerance of +/- 5%.
2. Actual efficacy value is dependent to specified LED driver (power supply). An estimated efficacy value can be calculated as follows: Lumen value divided by average power consumption per unit.
3. Do not install in environment where LED chips are exposed to direct sunlight as damage to the phosphor will occur. NEC definition of damp location: Locations protected from weather and not subject to saturation with water or other liquids but subject to moderate degrees of moisture. Examples of such locations include partially protected locations under canopies, marquees, roofed open porches, and like locations, and interior locations subject to moderate degrees of moisture, such as some basements, some barns, and some cold-storage warehouses.
4. Do not install product in an environment outside the listed ambient temperature. Exceeding the maximum ambient temperature may damage LED chips, reduce the total lamp life, lumen output, and/or adversely impact color consistency.
5. Operating temperature is measured according to the minimum and maximum ambient temperature environment.

# EMERY™ Ensemble Suspended Linear LED Fixture

SPECIFICATION SHEET

## COMPATIBLE PRODUCTS

### LED DRIVERS (Required)

The following Listed LED Drivers are recommended for compatibility and to meet NEC code when installed according to specifications. For additional LED Driver options see Diode LED's product page at: <https://www.diodeled.com/products/led-power-supplies.html>

### SWITCHEX® DRIVER + DIMMER SWITCH

SWITCHEX combines an LED driver and LED dimmer switch into a single integrated unit. Fits into standard switch boxes.

[SPEC SHEET](#)



SKU	L - LENGTH	W - WIDTH	H - HEIGHT
DI-24V-SE-60W	1.40 in.	2.10 in.	4.10 in.
DI-24V-SE-100W	1.40 in.	2.10 in.	4.10 in.

Fits in Standard Switch Box

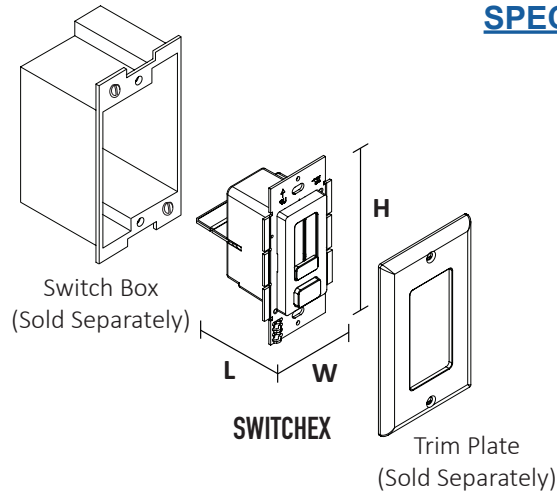

### LO-PRO® JUNCTION BOX & DRIVER COMBO - 24V CONSTANT VOLTAGE LED DRIVER

Use Constant Voltage Drivers to power your lighting system. Compatible with Standard 120VAC On/Off Switches, REIGN® Low Voltage Dimmers, TOUCHDIAL™ Control System, DMX Decoders, and PWM Controls.

[SPEC SHEET](#)

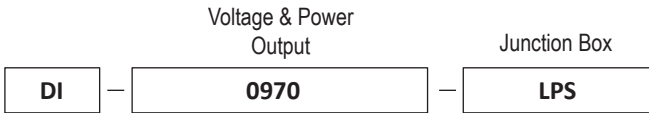

SKU	L - LENGTH	W - WIDTH	H - HEIGHT
DI-0970-LPS	11.25 in.	3.75 in.	1.90 in.
DI-CV-MW24V60W-277-LPS	11.25 in.	3.75 in.	1.90 in.
DI-CV-MW24V90W-277-LPS	11.25 in.	3.75 in.	1.90 in.
DI-0954-LPL	13.5 in.	4.5 in.	2.37 in.

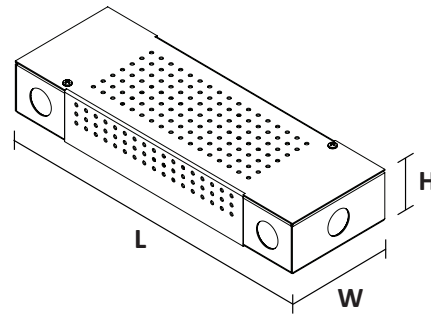

### LO-PRO® JUNCTION BOX & DRIVER COMBO - 24V COMMERCIAL GRADE 0-10V LED DIMMABLE DRIVER

Compatible with 0-10V controls and dimming systems.

[SPEC SHEET](#)

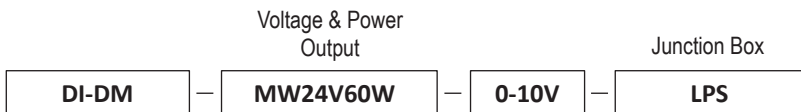

SKU	L - LENGTH	W - WIDTH	H - HEIGHT
DI-DM-MW24V60W-0-10V-LPS	11.25 in.	3.75 in.	1.90 in.
DI-DM-MW24V90W-0-10V-LPL	13.5 in.	4.5 in.	2.37 in.

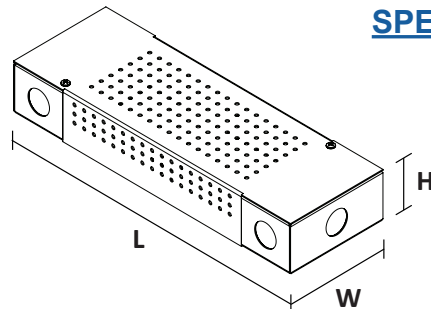

# EMERY™ Ensemble Suspended Linear LED Fixture

SPECIFICATION SHEET

## COMPATIBLE PRODUCTS

### LED DRIVERS Cont. (Required)

The following Listed LED Drivers are recommended for compatibility and to meet NEC code when installed according to specifications. For additional LED Driver options see Diode LED's product page at: <https://www.diodeled.com/products/led-power-supplies.html>

### OMNIDRIVE® 2 ELECTRONIC DIMMABLE LED DRIVER

OMNIDRIVE 2 features a zero minimum load and 100-5% dimming range. Compatible with Forward Phase and Reverse Phase Dimmers. Please see Diode LED's Compatibility List at: <https://www.diodeled.com/custom/download/productFile/filename/DI-OD2-Compatibility%20List.pdf>

[SPEC SHEET](#)



SKU	L - LENGTH	W - WIDTH	H - HEIGHT
DI-OD2-24V24W	13.75 in.	3.00 in.	1.60 in.
DI-OD2-24V60W	13.75 in.	3.00 in.	1.60 in.
DI-OD2-24V96W	15.00 in.	3.10 in.	2.40 in.
DI-OD2-24V120W	15.00 in.	3.10 in.	2.40 in.
DI-OD2-24V200W	16.10 in.	3.40 in.	2.40 in.

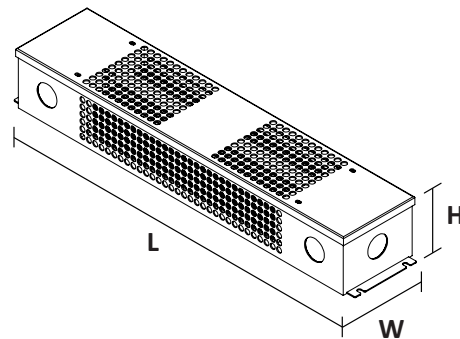

### LUTRON® Hi-lume 1% LED DIMMABLE DRIVER

Hi-lume 1% LED Driver has a minimum load of 5W and dims from 100-1%.

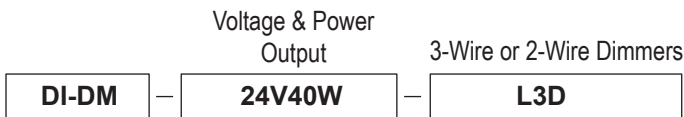

SKU	L - LENGTH	W - WIDTH	H - HEIGHT
DI-DM-24V40W-L3D	4.89 in.	4.00 in.	2.62 in.
DI-DM-24V40W-LTE			

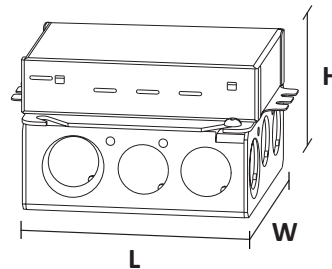

[L3D SPEC SHEET](#)

[LTE SPEC SHEET](#)



### LUTRON® Hi-lume Premier 0.1% LED DIMMABLE DRIVER

Hi-Lume Premier 0.1% LED Driver has a minimum load of 5W and dims from 100-0.1%.

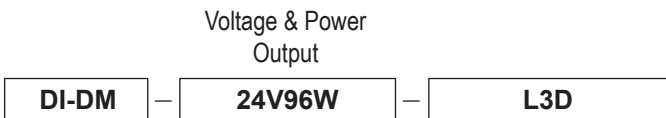

SKU	L - LENGTH	W - WIDTH	H - HEIGHT
DI-DM-24V96W-L3D	5.50 in.	2.20 in.	10.50 in.

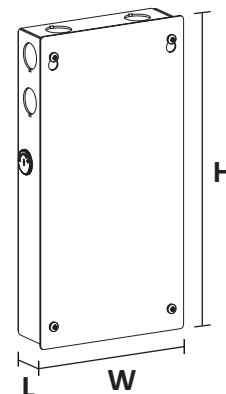

[SPEC SHEET](#)



# EMERY™ Ensemble Suspended Linear LED Fixture

SPECIFICATION SHEET

## COMPATIBLE PRODUCTS

### LED DRIVERS Cont. (Required)

The following Listed LED Drivers are recommended to meet NEC code when installed according to specifications. For additional LED Driver options see Diode LED's product page at: <https://www.diodeled.com/products/led-power-supplies.html>

## PLUG-IN ADAPTERS

Plug-In Adapters allow for a simple installation by plugging into a standard 120-Volt receptacle. Compatible with inline Switches and Dimmers.

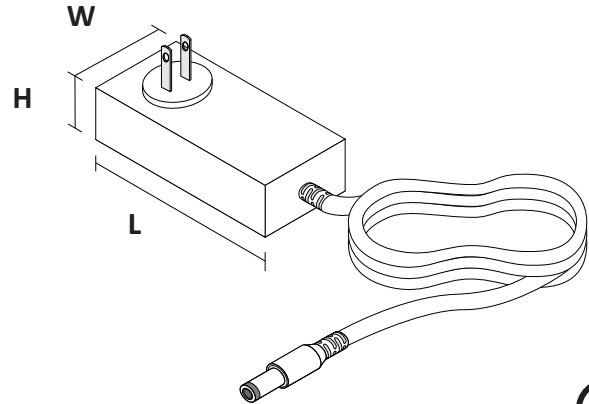
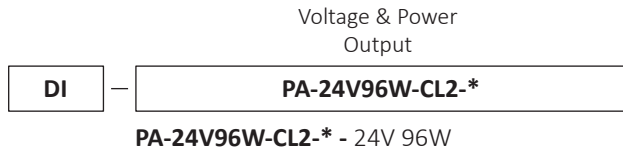

SKU	L - LENGTH	W - WIDTH	H - HEIGHT
PA-24V96W-CL2-*	4.70 in.	2.00 in.	1.25 in.

\* Available in Black or White. Add a **B** for Black or **W** for White.



## COMMERCIAL GRADE PLUG-IN DRIVER

Plug-In Adapters allow for a simple installation by plugging into a standard 120-Volt receptacle. Compatible with inline Switches and Dimmers.

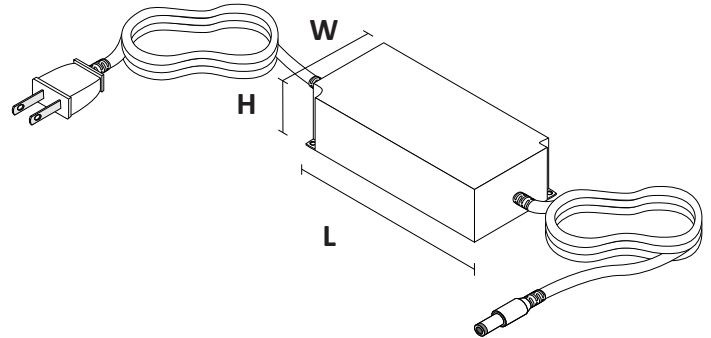
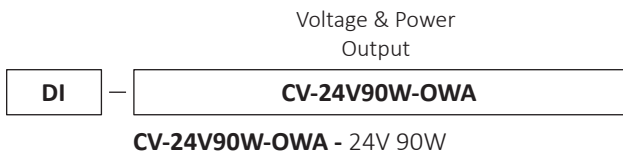

SKU	L - LENGTH	W - WIDTH	H - HEIGHT
CV-24V90W-OWA	6.75 in.	2.50 in.	1.50 in.



# EMERY™ Ensemble Suspended Linear LED Fixture

SPECIFICATION SHEET

## ADDITIONAL RESOURCES

- EMERY™ Ensemble Suspended Linear LED Fixture INSTALLATION GUIDE

## SAFETY / WARNINGS / DISCLOSURES

1. DO NOT Connect to 120VAC Power.
2. Install in accordance with the NEC and local regulations.
3. This product is intended to be installed and serviced by a qualified, licensed electrician.
4. This product MUST be powered with a compatible Class 2 24VDC LED driver and has not been evaluated for use when connected to a power source that does not comply with Class 2 voltage and energy limited supplies.
5. Suitable for Damp Locations. Do not install in wet locations or outdoors.
6. Attached wire leads, connectors and accessories are not rated for in-wall installation.
7. Attached wire leads are field-cuttable.

## WARRANTY

### Limited Warranty

This product has a three (3) year limited warranty from the date of shipment. This warranty does not include the additional accessories referenced in this specification sheet. Complete warranty details for fixtures and additional accessories are available at [www.DiodeLED.com](http://www.DiodeLED.com) under the 'Tools & Resources' tab. For warranty related questions please contact product support.

### Consumer's Acknowledgment

Elemental LED, Inc. stands behind its products when they are used properly and according to our specifications. By purchasing our products, the purchaser agrees and acknowledges that lighting design, configuration and installation is a complex process, wherein seemingly minor factors or changes in layout and in-field adjustments can have a significant impact on an entire system. Choosing the correct components is essential. Elemental LED is able to work with the original purchaser to make an appropriate product selection to the extent of the limited information that the customer can provide, but it is virtually impossible for Elemental LED to design a system that foresees every unknown factor. For this reason, this Warranty does not cover problems caused by improper design, configuration or installation issues. Any statement from an Elemental LED employee or agent regarding a customer's bill of goods and/or purchase order is NOT an acknowledgment that the products purchased are designed and configured correctly. The purchaser agrees and acknowledges that it is the customer's responsibility to adhere strictly to all information contained in the Product Specification Sheets.

There is often more than one way to design, configure and layout an LED lighting application properly to achieve the same lighting effect. Elemental LED strongly recommends that licensed professionals be used in the design and installation of lighting systems that include Elemental LED products. The specifications include important information that a designer and installer should carefully review and strictly follow. Qualified designers and certified and/or licensed installers, with access to the final installation environment, customer goals, and Elemental LED product specifications can make the requisite decisions appropriate for a successful finished lighting application.



© 2017 Elemental LED, Inc. All rights reserved.  
Specifications are subject to change without notice.

Toll Free: 877.817.6028 | Fax: 415.592.1596 | [www.DiodeLED.com](http://www.DiodeLED.com) | [info@DiodeLED.com](mailto:info@DiodeLED.com)